

Features

- 350Watts peak pulse power ($T_P = 8/20\mu s$)
- Tiny SOT-23 package
- Unidirectional configurations
- Protects two I/O port
- Low clamping voltage
- Low Leakage current
- ESD-immunity acc. IEC 61000-4-2 $\pm 30kV$ contact $\pm 30kV$ air
- IEC 61000-4-4 (EFT) 40A (5/50ns)
- IEC 61000-4-5 (Lightning) 15A (8/20 μs)

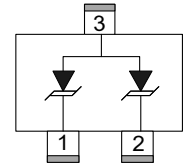
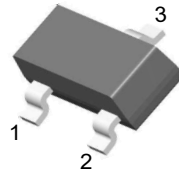

Mechanical Data

- **Case:** SOT-23 (plastic package).
Lead free; RoHS compliant; Halogen free
- **Molding Compound Flammability Rating:**
UL 94 V-0
- **Terminals:** High temperature soldering guaranteed:
260 °C/10 sec. at terminals

Applications

- Cellular Handsets and Accessories
- RS-232, RS-422 & RS-485
- Control & Monitoring Systems
- Set-Top Box
- Portable Electronics
- Other electronics equipments Communication systems

Absolute Maximum Ratings

Ratings at 25 °C, ambient temperature unless otherwise specified

Parameter	Symbol	Value	Unit
Peak Pulse Power ($T_P=8/20\mu s$)	P_{PP}	350	W
ESD contact/air discharge (IEC-61000-4-2)	V_{ESD}	30/30	kV
Peak Pulse Current ($T_P = 8/20\mu s$)	I_{PP}	15	A
Junction Temperature	T_J	-55 to +125	°C
Storage temperature	T_{STG}	-55 to +150	°C

Electrical Characteristics

($T_A = 25\text{ °C}$ unless otherwise specified)

Parameter	Symbol	Condition	Min	Typ	Max	Unit
Reverse stand-off Voltage	V_{RWM}				8	V
Reverse Breakdown Voltage	V_{BR}	$I_T=1mA$	9			V
Reverse Leakage Current	I_R	$V_{RWM}=8V$			0.5	μA
Clamping Voltage (IEC 61000-4-5)	V_C	$I_{PP}=15A$		25		V
Junction Capacitance	C_J	$V_R=0V, f=1MHz$		35		pF

Typical Characteristics ($T_{amb} = 25^\circ\text{C}$ unless otherwise specified)

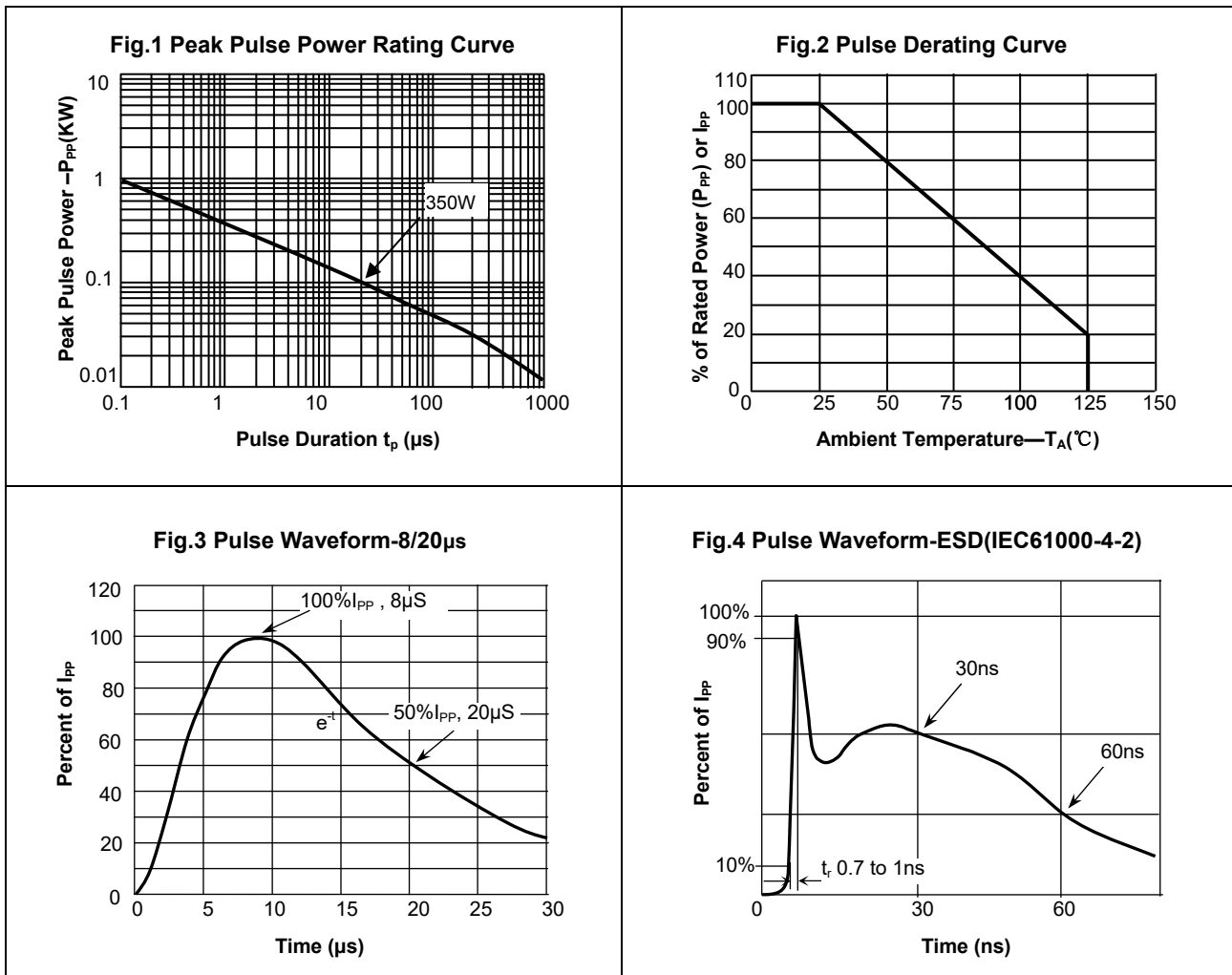

Package Dimensions

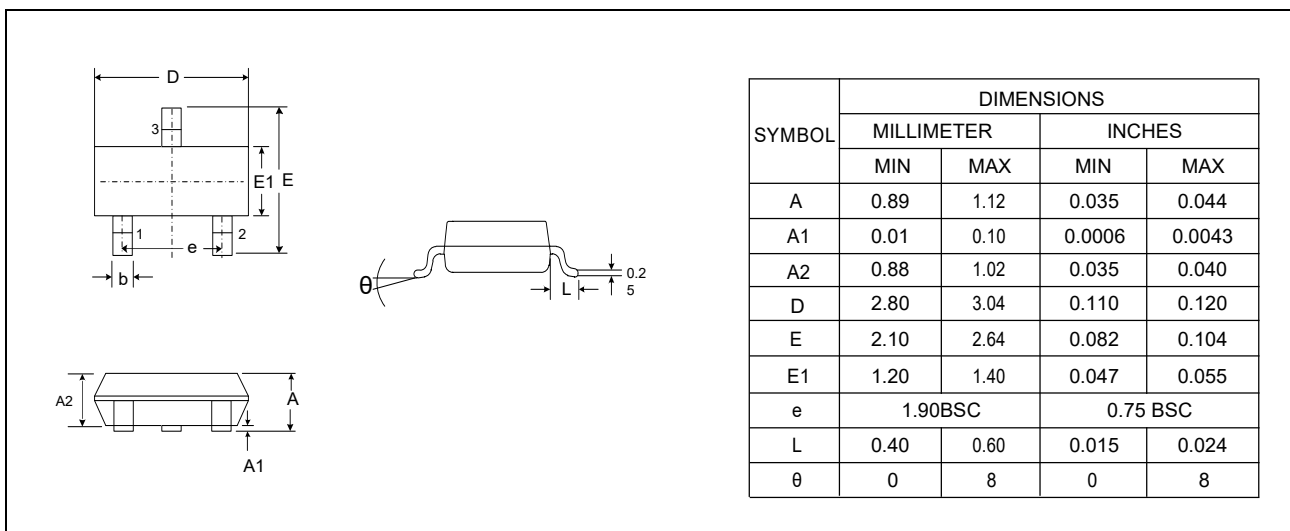

Pad Dimensions

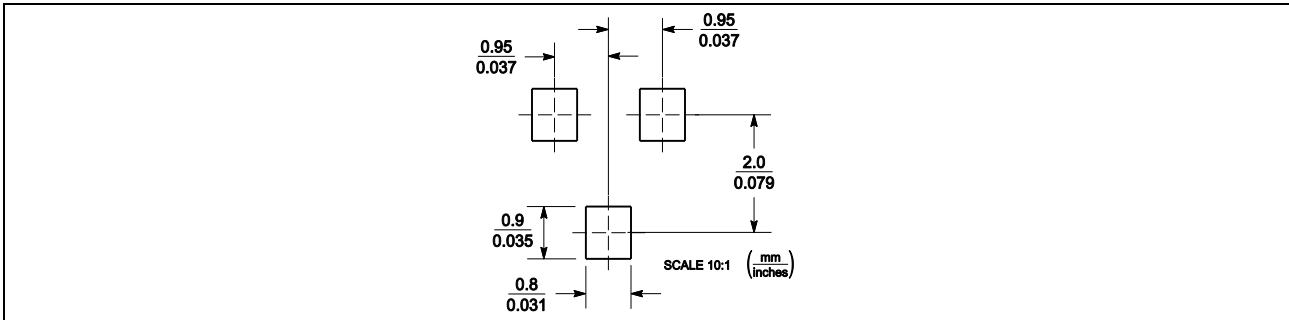

Package Information

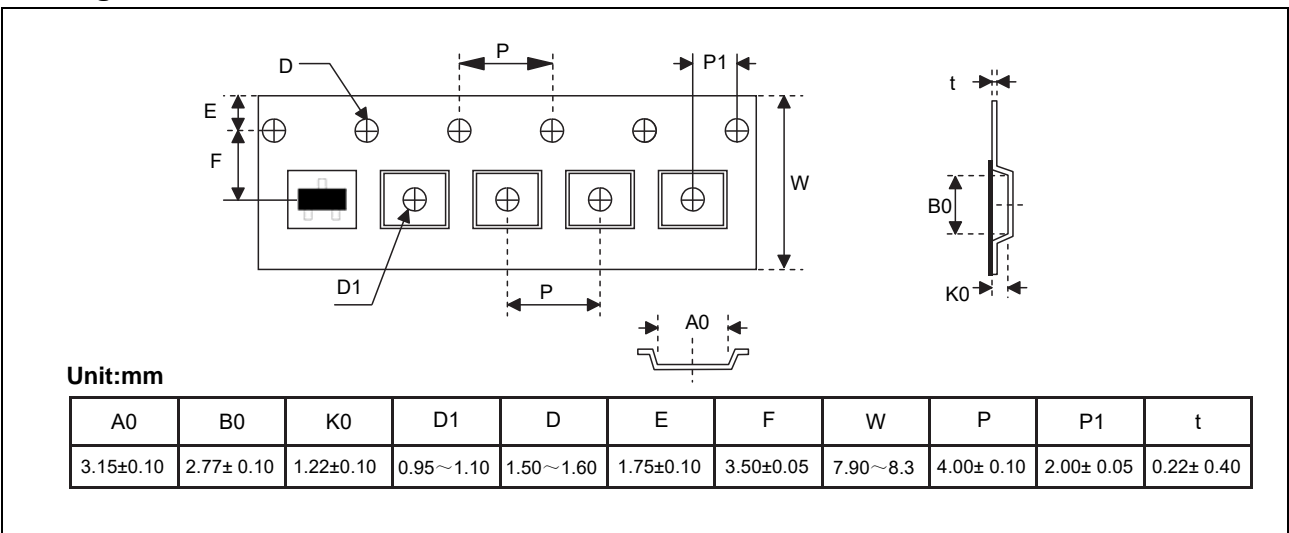

Marking

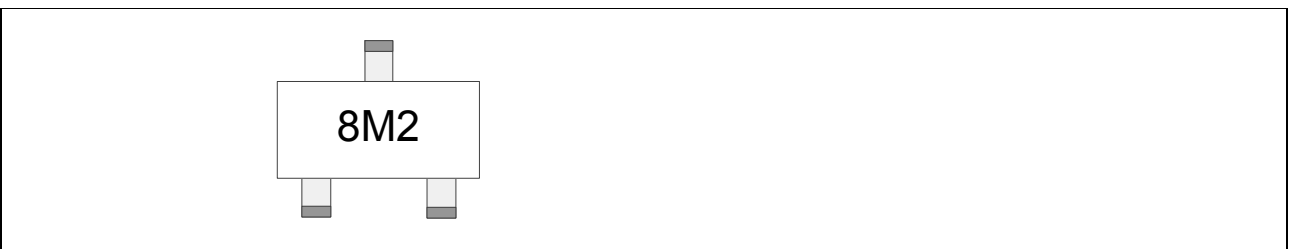

Ordering information

Order code	Package	Packaging option	Base quantity	Packaging specification
YEDST230815AV	SOT-23	Tape and reel	3000pcs / reel	EIA STD RS-481